

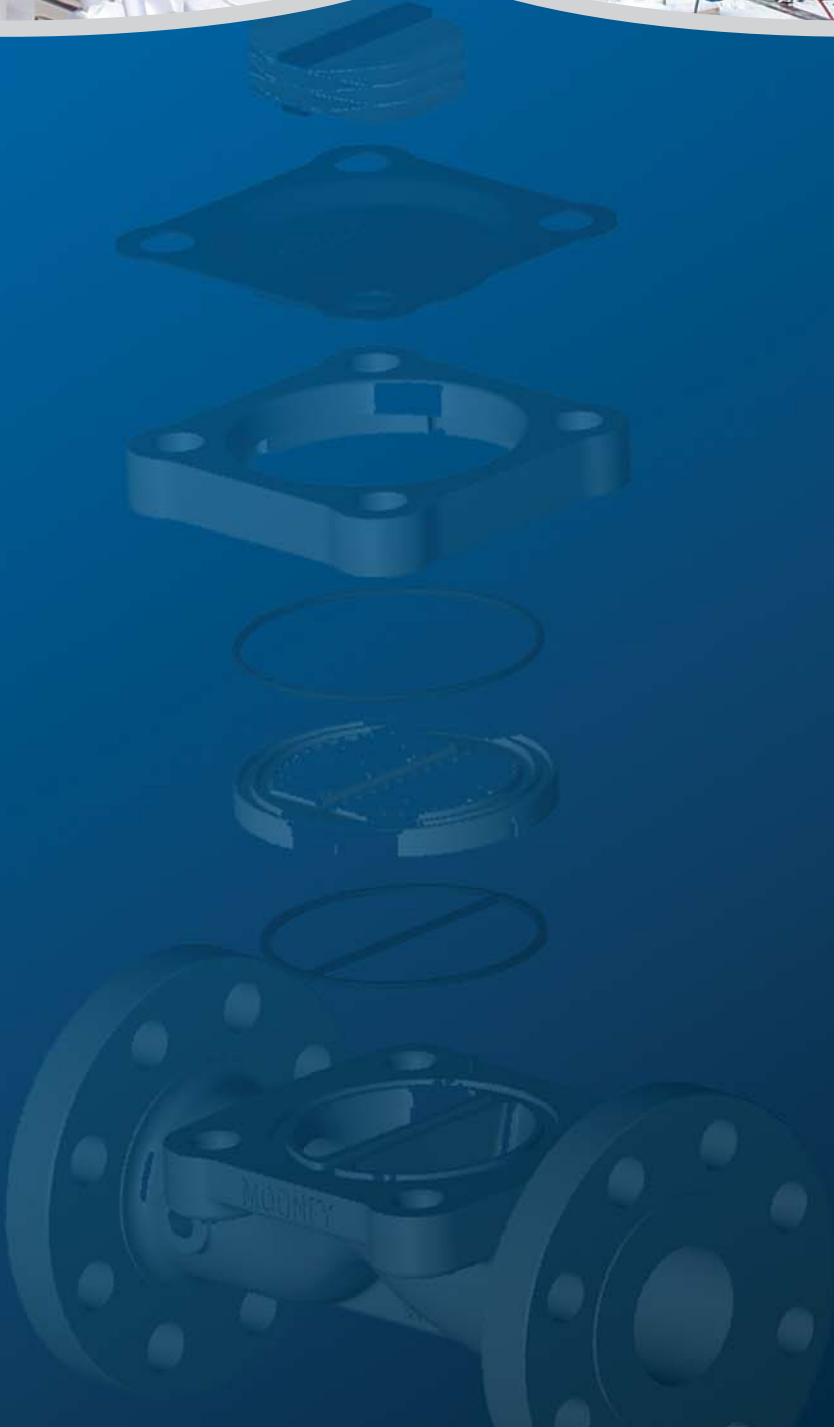

The Flowgrid[®] Regulator is designed for ease of maintenance

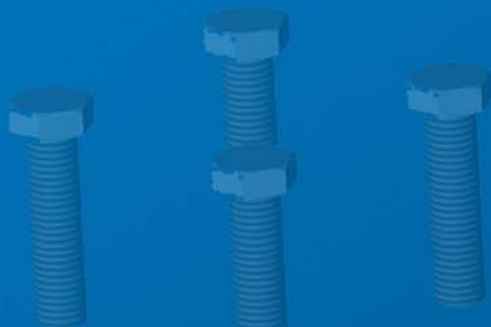



Mooney® Flowgrid® Regulator

The Mooney® Flowgrid® regulator was designed to fill the need for an easy-to-maintain valve that would be used primarily with self-contained pilot systems for pressure or flow control of almost any gas or liquid. These key design elements equate to increased productivity.

Extremely high accuracy of control, incredible responsiveness, wide rangeability, minimal parts and top entry access to all components makes the Mooney Flowgrid regulator the regulator of choice. Our customers tell us what they like most about the Mooney® Flowgrid regulator is....

“you just set it and forget it”.

Features

- In-line maintenance with minimal parts
- Rugged fabric-reinforced throttling element/diaphragm provides wide-rangeability, stability and fast response in severe service conditions
- Elliptical main spring provides a high frequency response, proportional action for stability, a consistent low minimum differential and shut off force
- Spring case has small volume to enhance speed of response and stability
- Over eighty-eight valve body options to fit any application
- Throttle plates offered in four standard capacities 100%, 50%, 75% and 35% or any custom capacity desired
- Symmetrical throttle plate design inhibits debris from accumulating under the seat and effecting shut-off
- Drilled-hole throttle plates for reduced noise and extended diaphragm life
- Equal inlet/outlet pressure rating for all sizes assures easy operation with no special start-up procedures
- Dual-port valve design provides redundancy with dual pilots and extra capacity with one pilot
- Compact size for easy installation in any position

Principle of Operation

Pressure Relieving Valve

At no flow, when the outlet pressure is greater than the set point of the Series 20® pilot regulator, the pilot is closed and full inlet pressure loads the main valve spring case through the pilot loading connection. In this condition, the main throttling element is closed tightly against the throttling plate. The pressure differential across the outlet half of the diaphragm adds to the spring force to close the valve (Fig 1).

As demand for flow occurs in the downstream system, the outlet pressure drops, causing the pilot to open and start bleeding pressure out of the spring case faster than it can enter through the restricting valve. Reducing the loading pressure above the diaphragm allows inlet pressure to progressively lift the diaphragm off the throttling plate, opening the valve and satisfying the demand for the flow in the downstream system (Fig 2).

When demand for flow ceases or is reduced, the downstream pressure increases, causing the pilot regulator to close. Inlet pressure continues to pass through the restriction until the loading pressure equals the inlet pressure.

The spring force, plus the pressure differential across the outlet half of the throttling plate closes the throttling element against the throttling plate closing the main valve (Fig 1).

Adjustment of the variable restricting valve affects the response rate, stability and sensitivity of the regulator. Smaller restrictor openings result in higher gain (sensitivity) and slower closing speeds. Larger openings result in lower gain (greater proportional band), greater stability, and faster closing speed.

Back Pressure Valve

In a back pressure relief application (BPV) the valve functions in the exact same way as previously described except that the sense line for the control pilot is located upstream of the regulator. The action of the pilot is the reverse of a pressure reducing pilot such that the pilot opens when system pressure increases above its set-point. The pilot will close when the system pressure is less than its set-point (Fig 3).

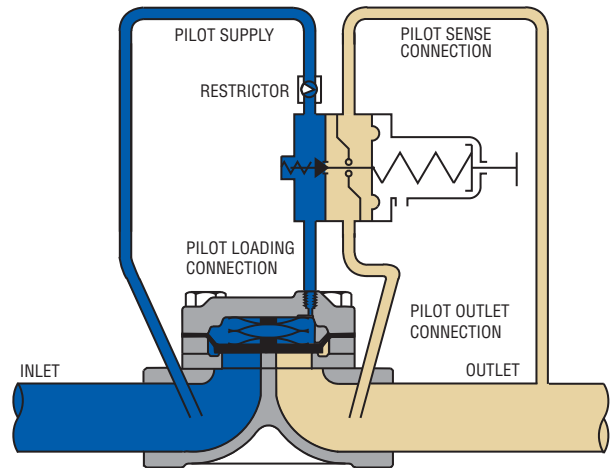

Fig 1. Pressure Reducing Configuration Fully Closed.

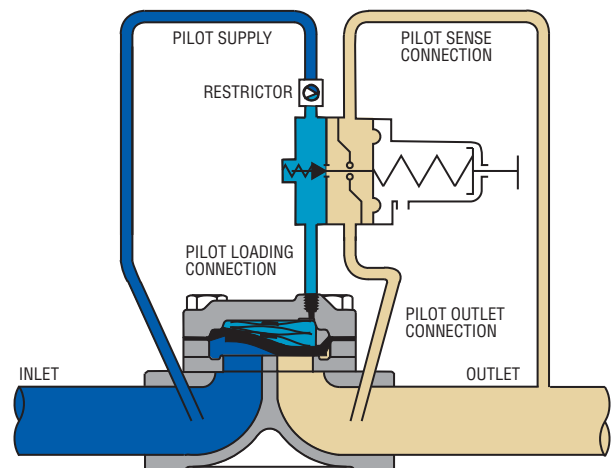

Fig 2. Pressure Reducing Configuration Partially Open.

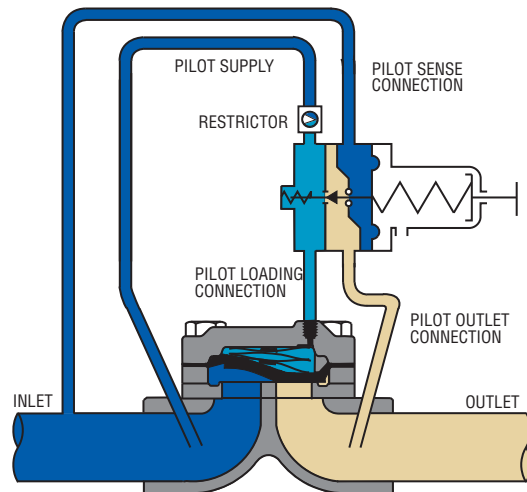
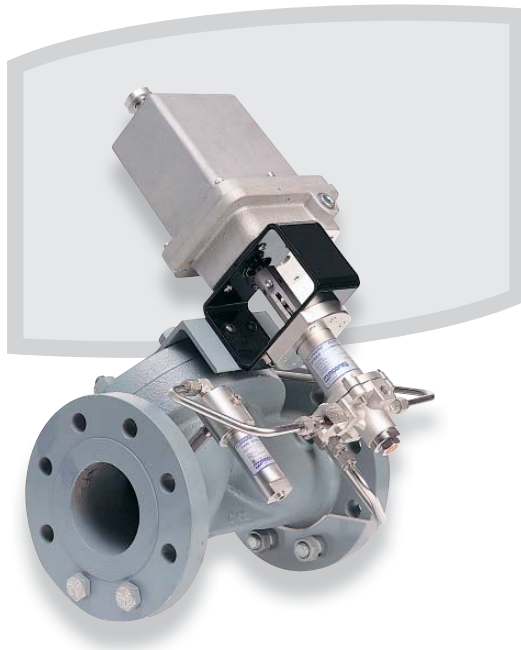

Fig 3. Back Pressure Valve



Set-Point Control

The Jordan® 1020 Actuator connected directly to any Series 20® pilot allows remote control of any set point between 5 i.w.c. and 900 psig. The actuator is available in a variety of electrical classifications, voltages and input signals.

Applications

The Flowgrid® is ideal for pressure reducing (PRV), back pressure or relief (BPV), flow-control, and multi-function control applications where good regulation, simplicity, and ease of maintenance are of prime importance.

The Flowgrid can handle gas and liquids that are relatively clean, noncorrosive, and compatible with standard carbon steel/17-4ph stainless steel/nitrile rubber construction. The normal temperature range is -20°F to 150°F. Alternative materials for conditions outside the normal temperature range are available.

The Flowgrid can easily be interfaced with conventional pneumatic, electronic or microprocessor-based controllers for a variety of pressure and flow control applications. These applications can often result in lower overall costs and substantial energy savings.

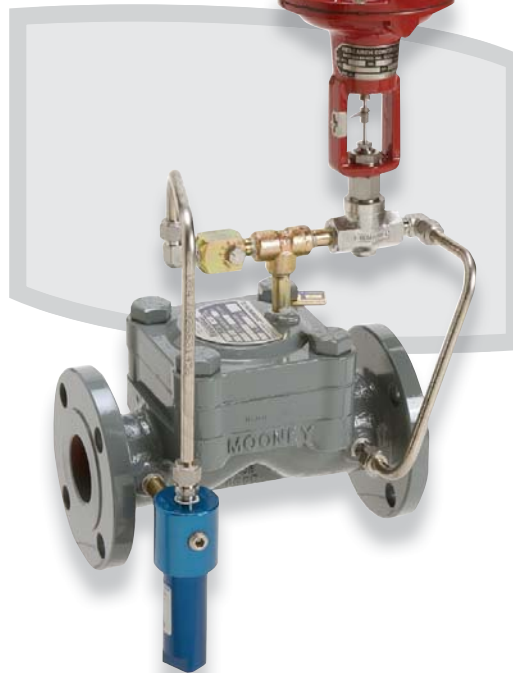

Pneumatic Control Application

A pneumatic input signal to a Badger® Control Pilot mounted on a Flowgrid® valve offers a variety of pressure, flow and remote set point options.

Remote control of the Series 20® pilot set point is also possible by pressure loading the spring case through the tapped vent connection.

Natural Gas Industry Applications

- District Regulator
- Monitor Regulator
- Relief Valve (BPV)
- Flow Control
- Compressor Fuel Gas
- Co-generation Fuel Supply

Industrial Applications

- Boiler Fuel Gas
- Oil
- Water
- Industrial Gasses (e.g., air, nitrogen, argon)
- Bi-directional Pressure Control
- Check Valve
- Differential Control Pressure or Flow

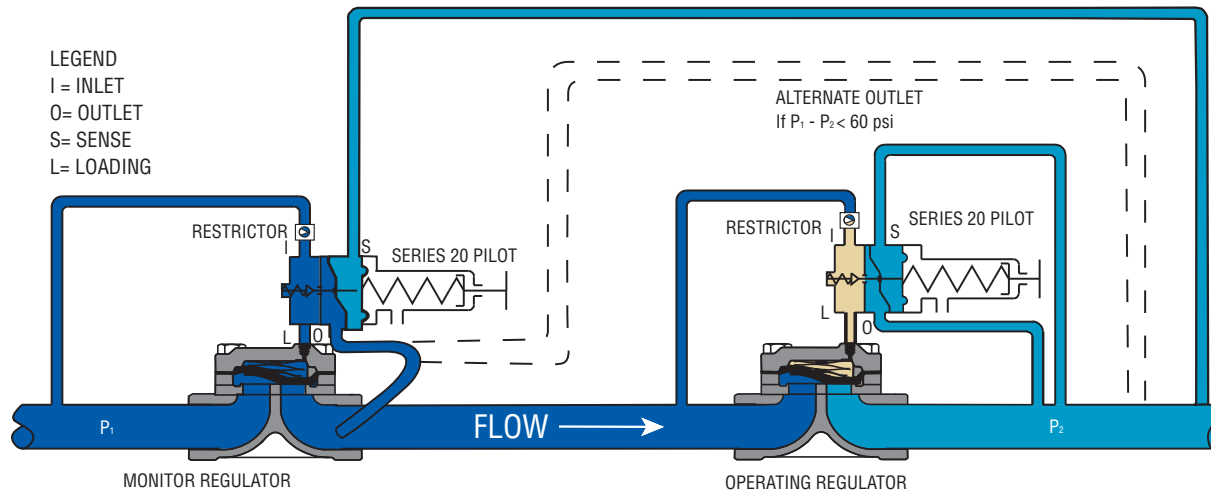

Standby Monitor System (Fig 4)

Under normal operating conditions, one of the Flowgrid® regulators operates as a worker while the other acts as a monitor of the system. The upstream or downstream regulator can serve either function.

The monitor pilot is set at a slightly higher pressure than the worker (e.g., +5%). If the operating regulator should fail, P₂ will increase until it reaches the set point of the monitor pilot, allowing the monitor regulator to take over protecting the downstream system P₂ from being over pressured.

NOTE: On dead-end systems, a token relief downstream of the second stage regulator is recommended to compensate for slight leaks due to wear or debris in the monitor regulator and/or operating regulator.

NOTE: Ref. Fig 4. Use alternative outlet to insure full capacity when the pressure drops across the regulator are less than 60 psid. **NOTE:** System will shut off at upstream pilot setting.

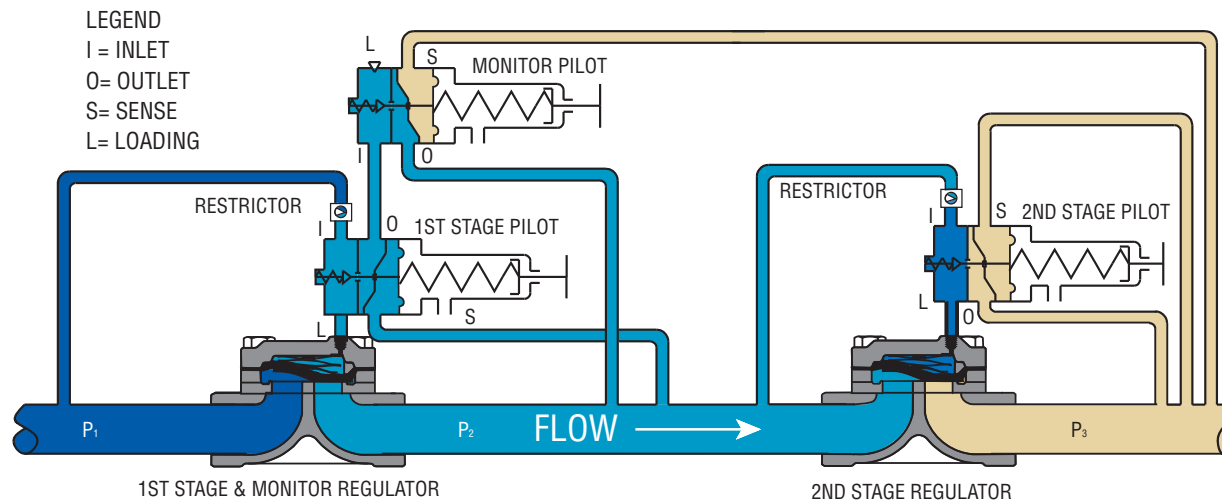

Working Monitor System (Fig 5)

Under normal conditions, both Flowgrid® regulators are working to reduce pressure in a two-stage sequence. If a problem occurs in the upstream regulator, the downstream regulator takes over the entire pressure cut, maintaining P₃ at the same pressure. If the downstream regulator fails, P₃ will rise, causing the monitor pilot on the upstream regulator to take over maintaining the pressure in the downstream system P₃ at the set point of the monitor pilot.





NOTE: On dead-end systems, a token relief downstream of the second stage regulator is recommended to compensate for slight leaks due to wear or debris in the monitor regulator.

NOTE: An additional benefit of this system is the lower noise level that results when the pressure is reduced in two stages.









Specifications

Sizes	1" - 12"
Body Styles	Single & Dual Port
Body Materials	Steel, Ductile Iron*
End Connections	Screwed, Socket Weld, Flanged, Flangeless & Buttweld
Outlet Pressures	5 i.w.c. - 900 psig
Maximum Operating Differential	800 psid, 1" 1000 psid
Maximum Emergency Differential	1,000 psid (unless limited by body rating) 1" 1500 psid
Cracking Differential	4± 1 psid
Temperature Range	-20°F to 150°F
Minimum/Maximum	-40°F to 175°F
Flow Direction	Bi-Directional

* Stainless steel available in some sizes. Factory quote required.

Spring Color	Type 20™ Pilot	Outlet Pressure Range
White 	20L	5-15 i. w. c.
Brown 	20L	10-40 i. w. c.
Yellow 	20L	1-3 psig
Orange 	20L	2-5 psig
Gray 	20L	4-8 psig



Spring Color	Type 20™ Pilot	Outlet Pressure Range
Red 	20	3-12 psig
Cadmium 	20	10-40 psig
Blue 	20	25-90 psig
Purple 	20	60-200 psig
Black 	20	100-260 psig
White/Green 	20	200-450 psig
Black 	20HP	200-520 psig
White/Green 	20HP	400-900 psig



Pilot available in:
20L Aluminum & Bronze, 20 Brass and SST, 20H Brass and SST

Guidelines for Diaphragm Selection

Compound	Temperature Range (Degrees F)	Maximum Differential 1" Value	Maximum Differential All Others	Characteristics	Recommended Applications
75 Duro (standard)	-20 to 150	1000 psid	800 psid	Best all around material	60 psid to Maximum Differential
60 Duro*	-25 to 150	300 psid*	300 psid*	Best shutoff at low differential pressure	Low Differential (100 psid or less) or low temperature
80 Duro High ACN	-5 to 175	1000 psid	800 psid	Higher abrasion and swelling resistance	High Differential (400 psid or higher) or abrasive conditions with distillates
80 Duro Low ACN	-20 to 150	1000 psid	800 psid	Higher abrasion resistance and low temperature flexibility	High Differential (400 psid or higher) or abrasive conditions at low temperatures

NOTE: Minimum temperature is defined as lowest temperature for normal valve operation. Valve will operate below this temperature, but response times may increase and bubble-tight shutoff may be impaired. At extreme low temperatures below -40° F, flexure of the diaphragm may result in cracking of the material. This will require replacement of the diaphragm. Maximum differentials listed are recommended for best diaphragm life. Exceeding these differentials will not result in diaphragm damage, but may accelerate wear of the part.

* The 60 durometer diaphragm is standard on the Flowgrid® 250 Valve which is a ductile iron and aluminum construction with a maximum inlet and differential rating of 250 psi.

Valve Performance

Performance with Series 20L™ and Series 20™ Pilot

Mooney® Series 20L Pilot		Pressure Reducing Mode Restrictor Set at 4		
Pilot Spring	Range	Lockup	Drop Maximum Capacity ¹	Boost @ Constant Flow
White	5 i.w.c. - 15 i.w.c.	1.0 i.w.c.	0.5 i.w.c.	0.7 i.w.c.
Brown	10 i.w.c. - 40 i.w.c.	1.0 i.w.c.	2 i.w.c.	0.7 i.w.c.
Yellow	1-3 psig	0.2 psig	0.15 psig	0.25 psig
Orange	2-5 psig	0.35 psig	0.25 psig	0.25 psig
Gray	4-8 psig	.5 psig	0.30 psig	0.25 psig

Mooney® Series 20 Pilot		Pressure Reducing Mode Restrictor Set at 4			Back Pressure Mode Restrictor Set at 4	
Pilot Spring	Range	Lockup	Drop ¹ Maximum Capacity	Boost at ² Constant Flow	Buildup Maximum Capacity	Lockup
Red	3-12 psig	1.0 psig	.30	.70 psig	⁴	⁴
Cadmium	10-40 psig	1.0 psig	.30	.70 psig	+ .50 psig	-1.0 psig
Blue	25-90 psig	2.0 psig	.60	.70 psig	+ .50 psig	-1.0 psig
Purple	60-200 psig	2.0 psig	1.30	.70 psig	+ 1.0 psig	-1.0 psig
Black	100-260 psig	5.0 psig	2.00	.70 psig	+ 3.0 psig	-1.5 psig
Green	200-450 psig	10.0 psig	4.00	.70 psig	+ 5.0 psig	-2.0 psig
HP Black	200-520 psig	10.0 psig	4.00	1.50 psig	+ 5.0 psig ³	-3.0 psig
HP Green	400-900 psig	20.0 psig	8.00	1.50 psig	+12.0 psig ³	-5.0 psig

1 Inlet pressure (P_i) constant

2 Per 100 psi decrease in inlet pressure (P_i)

3 SST/Delrin trim required

4 Minimum set point for the Flowgrid Valve and Pilot when used as a relief valve is 15 psig or the minimum differential, whichever is greater.

Minimum Pressure Differential Versus Capacity

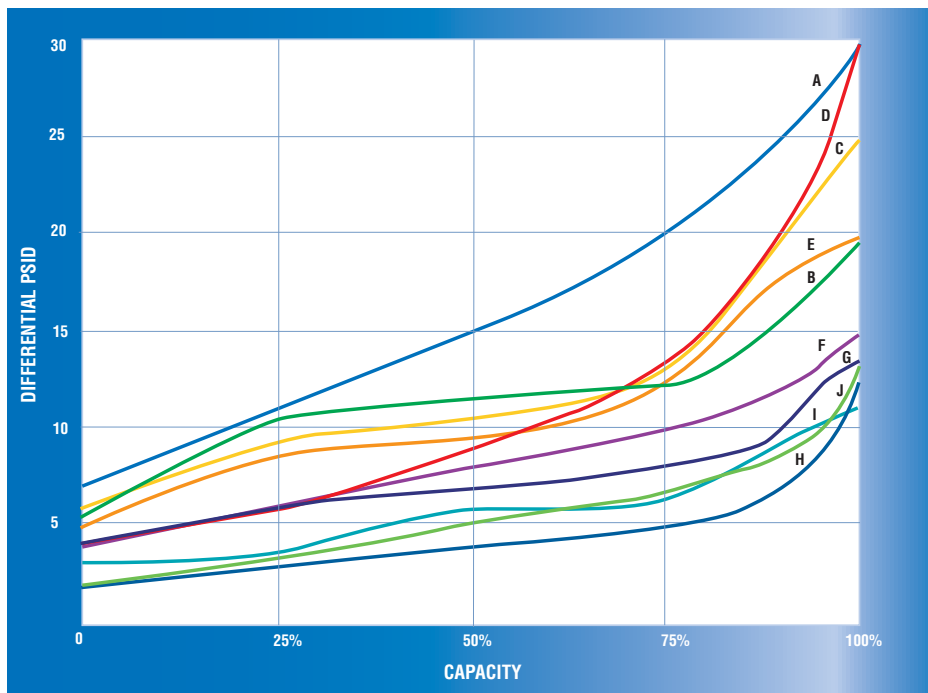

- A** 1" 75 Duro, STD Spring
- B** 1" 60 Duro, Low Spring
- C** 2" LP 75 Duro, STD Spring
- D** 3" 75 Duro, STD Spring
- E** 2" STD 75 Duro, STD Spring
- F** 4", 6" 75 Duro, STD Spring
- G** 2" STD 60 Duro, Low Spring
- H** 4", 6" 60 Duro, Low Spring
- I** 2" LP 60 Duro, Low Spring
- J** 3" 60 Duro, Low Spring

Use the chart at left to determine the amount of available capacity through a Flowgrid® valve when the differential pressure across the regulator falls below 30 psid.

For example: At 15 psid a 1" single port valve with a standard main spring and 75 durometer diaphragm (A) can flow 50% of total calculated capacity in this condition. With a low differential main spring and 60 durometer diaphragm is installed (B) the valve can flow 100% of its calculated capacity.

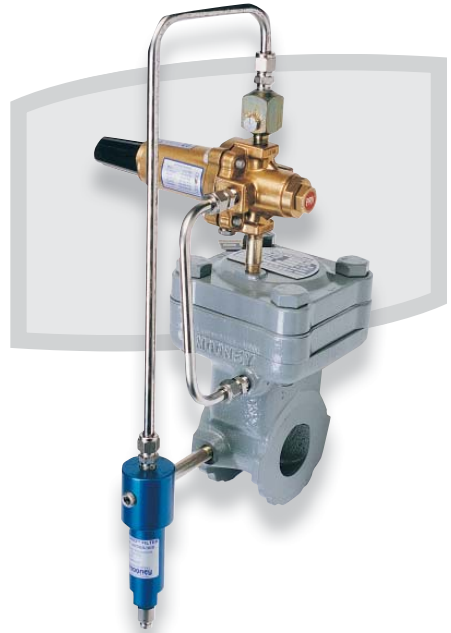

Universal Gas Sizing Equation

$$Q = \sqrt{\frac{520}{G \cdot T}} \cdot C_g \cdot P_1 \cdot \text{SIN} \left[\frac{3417}{C_1} \sqrt{\frac{\Delta P}{P_1}} \right] \text{ deg.}$$

$$C_g = \frac{Q}{P_1 \sqrt{\frac{520}{G \cdot T}} \cdot \text{SIN} \left[\frac{3417}{C_1} \sqrt{\frac{P_1 - P_2}{P_1}} \right] \text{ deg.}}$$

Simplifies 1.29
Simplifies 1.00

Natural Gas at 60° F & 0.6 Sg
Critical Flow

Q	Flow Rate (SCFH)
Cg	Gas Sizing Coefficient
P₁	Inlet Pressure (psia)
ΔP	Pressure Drop Across Valve (ΔP = P ₁ - P ₂) (psid)
P₂	Outlet Pressure (psia)
C₁	Valve Recovery Coefficient (C ₁ = C _g /C _v)
Cv	Liquid Sizing Coefficient
G	Specific Gravity (0.6 for Natural Gas) (1.0 for Air)
T	Gas Temperature (°Rankine) (T - 460 + °F)

Simplified Gas Sizing Equation

In the following term (P₁ - P₂) / P₁ equals .64 or greater, then sonic velocity is present in the valve and the simplified version of the gas-sizing equation may be used.

Air: Q = P₁ C_g **Natural Gas:** Q = P₁ C_g 1.29

NOTE: Valve sizing and selection software is available for download at: dresser.com/mooney

Liquid Sizing

$$Q = C_v F_p \sqrt{\frac{\Delta P_A}{G}}$$

ΔP_A or ΔP	Allowable	G	Liquid Specific Gravity
ΔP_A	P ₁ - P ₂ or .8 (P ₁ - P _v) } whichever is less	P₁	Inlet Pressure (psia)
Q		Flow gpm (gallons per minute)	P₂
Cv	Liquid Specific Gravity	P_v	Vapor Pressure (psia)
		F_p	Piping Swage Factor

Use the minimum inlet and maximum flow conditions for a given application and solve the equation for C_g. For optimum performance, select a regulator to operate in the 10-80% range. A Dresser representative can help you select and size a Flowgrid® regulator.

Gas Velocity

To avoid generating additional noise in the outlet piping, it is recommended that the body outlet velocity be limited to approximately 0.5 of Mach. This equates to approximately 500 ft/sec for air and 700 ft/sec for natural gas. Swages (reducers) should be used to further reduce the outlet piping velocity to approximately 200 ft/sec or less to minimize pressure loss. The formulas for velocity and pipe size are as follows:

$$V = \frac{748 Q}{d^2 P_2}$$

V	Velocity in ft/sec
d	Internal pipe diameter in inches
Q	Flow in MSCFH
P₂	Outlet Pressure (psia)

NOTE: To avoid the possibility of excessive noise, vibration, and damage to the regulator and piping, the outlet velocity should not exceed 70% of sonic velocity.

Air: 770 ft/sec **Natural Gas:** 1000 ft/sec

Single Port Designs

Nominal Size inches	Stock No.	End Connections	Max Pressure (psig)	Nominal Port Size	C _g	C _v	C _i	Face to Face inches (metric)	Weight (valve only)
1	FG11 & 12	NPT/SWE	1480	1"	450	13.4	34	7.00 (178)	11 lbs.
1	FG 54**	150 CL FLG	285	1"	450	13.4	34	7.25 (184)	14 lbs.
1	FG 55 **	300 CL FLG	740	1"	450	13.4	34	7.75 (197)	16 lbs.
1	FG 56**	600 CL FLG	1480	1"	450	13.4	34	8.25 (210)	18 lbs.
1-1/4	FG 13 & 14	NPT/SWE	1480	1"	450	13.4	34	7.00 (178)	11 lbs.
1-1/2	FG 47 & 48	NPT/SWE	1480	1"	480	13.4	36	7.00 (178)	11 lbs.
1	FG 24	NPT	250*	1"	428	13.1	32	7.00 (178)	8 lbs.
1-1/4	FG 25	NPT	250*	1"	432	13.6	31	7.00 (178)	8 lbs.
1-1/2	FG 26	NPT	250*	1"	457	14	32	7.00 (178)	8 lbs.
2 x 1	FG 29 & 50	NPT/SWE	1480	1"	500	13.4	37	7.00 (178)	14 lbs.
2 x 1	FG 51	150 CL FLG	285	1"	500	13.4	37	10.00 (254)	23 lbs.
2 x 1	FG 52	300 CL FLG	740	1"	500	13.4	37	10.50 (267)	26 lbs.
2 x 1	FG 53	600 CL FLG	1480	1"	500	13.4	37	11.25 (286)	30 lbs.
2	FG 1 & 2	NPT/SWE	1480	2" Std	1130	32	35	8.00 (203)	25 lbs.
2	FG 3	150 CL FLG	285	2" Std	1130	32	32	10.00 (254)	37 lbs.
2	FG 4	300 CL FLG	740	2" Std	1130	32	35	10.50 (267)	39 lbs.
2	FG 5	600 CL FLG	1480	2" Std	1130	32	35	11.25 (286)	43 lbs.
2	FG 27 & 28	NPT/SWE	1480	2" LP	1420	40	35	8.00 (203)	25 lbs.
2	FG 29	150 CL FLG	285	2" LP	1420	40	35	10.00 (254)	34 lbs.
2	FG 30	300 CL FLG	740	2" LP	1420	40	35	10.50 (267)	37 lbs.
2	FG 31	600 CL FLG	1480	2" LP	1420	40	35	11.25 (286)	40 lbs.
2	FG 82	NPT	250*	2" LP	1600	46	35	8.00 (203)	17 lbs.
2	FG 83	150 CL FLG RF	250*	2" LP	1600	46	35	10.00 (254)	22 lbs.
2	FG 84	150 CL FLG FF	250*	2" LP	1600	46	35	10.00 (254)	22 lbs.
2 x 3	FG 119	150 CL FLG	285	3"	1970	56	35	10.00 (254)	78 lbs.
2 x 3	FG 120	300 CL FLG	740	3"	1970	56	35	10.50 (267)	82 lbs.
2 x 3	FG 121	600 CL FLG	1480	3"	1970	56	35	11.25 (286)	88 lbs.
2 x 3	FG 117	NPT CL 600	1480	3"	1970	56	35	8.00 (203)	68 lbs.
2 x 3	FG 118	SWE CL 600	1480	3"	1970	56	35	8.00 (203)	68 lbs.
3	FG 16	150 CL FLG	285	3"	3450	96	36	11.75 (298)	73 lbs.
3	FG 17	300 CL FLG	740	3"	3450	96	36	12.50 (317)	85 lbs.
3	FG 18	600 CL FLG	1480	3"	3450	96	36	13.25 (337)	94 lbs.
4	FG 39	150 CL FLG	285	4"	6500	172	38	13.88 (352)	103 lbs.
4	FG 40	300 CL FLG	740	4"	6500	172	38	14.50 (368)	117 lbs.
4	FG 41	600 CL FLG	1480	4"	6500	172	38	15.50 (394)	143 lbs.
6	FG 44	150 CL FLG	285	6"	12500	313	40	17.75 (451)	200 lbs.
6	FG 45	300 CL FLG	740	6"	12500	313	40	18.62 (473)	240 lbs.
6	FG 46	600 CL FLG	1480	6"	12500	313	40	20.00 (508)	330 lbs.
8	FG 72	150 CL FLG	285	8"	20200	530	38	21.38 (543)	450 lbs.
8	FG 72	300 CL FLG	740	8"	20200	530	38	22.38 (568)	500 lbs.
8	FG 80	600 CL FLG	1480	8"	20200	530	38	24.00 (610)	650 lbs.

* Ductile Iron & Aluminum ** Special welded assembly

Dual Port Designs

Nominal Size inches	Stock No.	End Connections	Max Pressure (psig)	Nominal Port Size	C _g	C _v	C ₁	Face to Face inches (metric)	Weight (valve only)
2	FG 8	150 CL FLG	285	2" Std	1960	56	35	10.00 (254)	52 lbs.
2	FG 9	300 CL FLG	740	2" Std	1960	56	35	10.50 (267)	55 lbs.
2	FG 10	600 CL FLG	1480	2" Std	1960	56	35	11.25 (286)	59 lbs.
2	FG 32	150 CL FLG	285	2" LP	2050	59	35	10.00 (254)	50 lbs.
2	FG 33	300 CL FLG	740	2" LP	2050	59	35	10.50 (267)	52 lbs.
2	FG 34	600 CL FLG	1480	2" LP	2050	59	35	11.25 (286)	54 lbs.
4	FG 21	150 CL FLG	285	3"	6700	185	36	13.88 (352)	145 lbs.
4	FG 22	300 CL FLG	740	3"	6700	185	36	14.50 (368)	160 lbs.
4	FG 23	600 CL FLG	1480	3"	6700	185	36	15.50 (394)	194 lbs.
10	FG 57	150 CL FLG	285	6"	22000	550	40	26.50 (673)	590 lbs.
10	FG 58	300 CL FLG	740	6"	22000	550	40	27.88 (708)	670 lbs.
10	FG 59	600 CL FLG	1480	6"	22000	550	40	29.60 (752)	900 lbs.
12	FG 74	150 CL FLG	285	8"	40400	1060	38	29.00 (737)	1097 lbs.
12	FG 75	300 CL FLG	740	8"	40400	1060	38	30.50 (775)	1195 lbs.
12	FG 81	600 CL FLG	1480	8"	40400	1060	38	32.25 (819)	1383 lbs.

Flangeless Port Designs

Nominal Size inches	Stock No.	End Connections	Max Pressure (psig)	Nominal Port Size	C _g	C _v	C ₁	Face to Face inches (metric)	Weight (valve only)
2	FG 15	150 CL FLG	285	2" Std	1120	32	35	4.187 (106)	27 lbs.
2	FG 15	300 CL FLG	740	2" Std	1120	32	35	4.187 (106)	27 lbs.
2	FG 15	600 CL FLG	1480	2" Std	1120	32	35	4.187 (106)	27 lbs.
2	FG 35	150 CL FLG	285	2" LP	1300	37	35	4.187 (106)	27 lbs.
2	FG 35	300 CL FLG	740	2" LP	1300	37	35	4.187 (106)	27 lbs.
2	FG 35	600 CL FLG	1480	2" LP	1300	37	35	4.187 (106)	27 lbs.
4 x 3	FG 19	150 CL FLG	285	3"	3400	95	36	5.81 (148)	92 lbs.
4 x 3	FG 20	300 CL FLG	740	3"	3400	95	36	5.81 (148)	92 lbs.
6 x 4	FG 42	150 CL FLG	285	4"	6400	172	37	8.00 (203)	115 lbs.
6 x 4	FG 43	300 CL FLG	740	4"	6400	172	37	8.00 (203)	115 lbs.

Type-A Flangeless Port Designs*

Nominal Size inches	Stock No.	End Connections	Max Pressure (psig)	Nominal Port Size	C _g	C _v	C ₁	Face to Face inches (metric)	Weight (valve only)
2	FG 100	150 CL FLG	285	2" LP	1420	40	35	3.03 (77)	29 lbs.
2	FG 101	300 CL FLG	740	2" LP	1420	40	35	3.03 (77)	29 lbs.
2	FG 102	600 CL FLG	1480	2" LP	1420	40	35	3.41 (87)	29 lbs.
3	FG 103	150 CL FLG	285	3"	3240	95	36	3.72 (94)	60 lbs.
3	FG 104	300 CL FLG	740	3"	3240	95	36	3.72 (94)	60 lbs.
4	FG 106	150 CL FLG	285	4"	5800	168	35	4.50 (114)	85 lbs.
4	FG 107	300 CL FLG	740	4"	5800	168	35	4.50 (114)	85 lbs.

* Same face-to-face dimensions as American Meter Axial® Flow Valves.

About Dresser® Products

Dresser brand products are highly engineered, technically superior and are designed to help global customers meet and exceed requirements for mission critical energy applications.

About Dresser, Inc.

Dresser, Inc. is a leader in providing highly engineered infrastructure products for the global energy industry. The company has leading positions in a broad portfolio of products, including valves, actuators, meters, switches, regulators, piping products, natural gas-fueled engines, retail fuel dispensers and associated retail point-of-sale systems, and air and gas handling equipment. Leading brand names within the Dresser portfolio include Dresser Wayne® retail fueling systems, Waukesha® natural gas-fired engines, Masoneilan® control valves, Consolidated® pressure relief valves, and Roots® blowers. It has manufacturing and customer service facilities located strategically worldwide and a sales presence in more than 100 countries.

The information presented in this brochure is for informational purposes only. For actual design assistance please visit our website at www.dresser.com/mooneyregulators or see your local representative.

Dresser, Inc.

2822 S. 1030 W.
Salt Lake City, Utah 84119
Phone: 801.487.2225 Fax: 801.487.2587
www.dresser.com/mooney

